



CLOUD INTELLIGENT OUTDOOR ARCHITECTURAL LED LIGHTS POWERED BY PoE

WARNING - BEFORE INSTALLATION

POEWIT POE POWERED ARCHITECTURAL LIGHTS CAN BE MOUNTED OUTDOORS, ON A WALL OR CEILING. THE LIGHT HOUSING IS WATER-RESISTANT; HOWEVER, THE ACCOMPANYING POE LED DRIVER IS NOT WATER-RESISTANT.

THIS POE LED DRIVER IS DESIGNED TO BE SECURELY MOUNTED IN A LOCATION FREE OF MOISTURE, SUCH AS INSIDE THE CAVITY OF THE WALL.

IN CERTAIN INSTALLATIONS, THE INSTALLER MAY EXTEND THE TWO CONDUCTOR WIRES (+ AND -) CONNECTING THE POE DRIVER TO THE LIGHT FIXTURE. WE RECOMMEND USING AT LEAST AN 20AWG WIRE AND 25 FEET OR LESS TO PREVENT VOLTAGE DROPS.

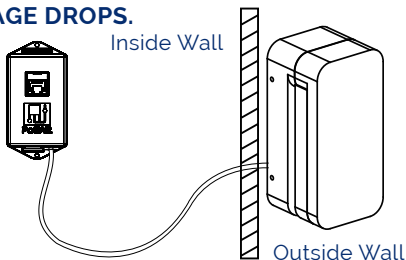



BEFORE YOU START

1) PACKAGE CONTENTS

Confirm that you have the package contents as follows:

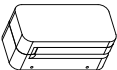
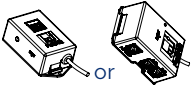
1. OD-2 PoE Powered LED Flood Light
or
2. OD-2-PT PoE powered LED flood light with PoE pass-through
3. Hardware screw bag
4. Quick start guide

PACKAGE CONTENT			
ITEM	OD-2 or OD-2-PT	PoE Driver	Quick start
QUANTITY	1	1	1

2) INSTALLATION AND SETUP

1. Select a proper location for light fixture and other connected devices.
2. Install Category Cable (CAT5e/6/7) from your PoE-enabled router or broadband modem to the location selected for light installation.
3. Loosen the four screws holding the light housing back mounting plate See figure 1

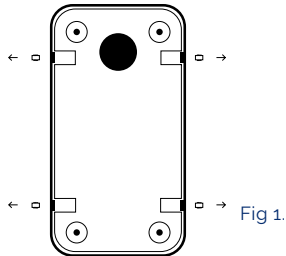

4. Insert category cable into PoE light driver and pull the light driver cable through the back mounting plate opening. Mount the back mounting plate to the wall with the four screws. See figure 2

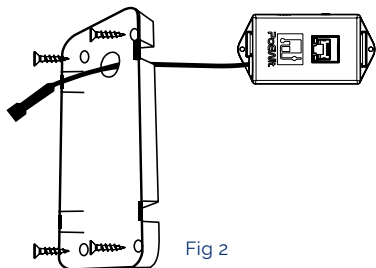

5. Connect the light housing to the PoE driver wire. See figure 3

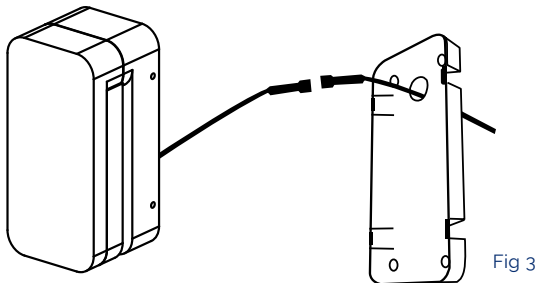

6. Push the cable assembly into the wall cavity and secure the water tight grommet onto the back mounting plate. See figure 4

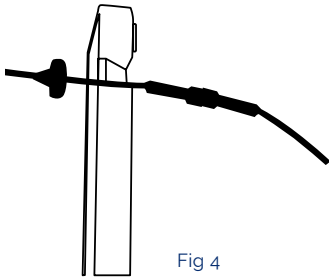
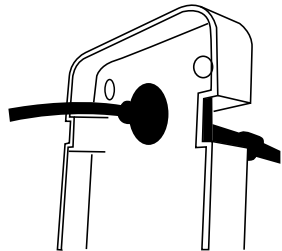

Fig 4



7. Attach the Light Housing to the Back Mounting Plate and tighten the four screws. See figure 5

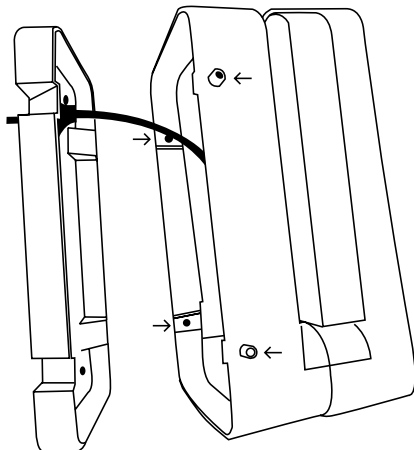

Fig 5



3) CONFIGURATION INSTRUCTIONS

Power up device; you should be automatically connected to the internet. You are now ready to download and install your app.

You can search PoEWit in the apple app store or Google Play to get the app

Note: Your device and mobile phone both must have an internet connection through the same external IP address and must be on the same local subnet.

After initial configuration, a PoEWit wall switch and/or PoEWit motion detector PIR can control the lights should the internet connection go down.

